



COMBINED SEARCH DEVICE ST 600



OPERATING MANUAL

CONTENTS

1. Purpose.....	2
2. Specifications	2
3. Delivery kit.....	3
4. Design	4
4.1. Main unit.....	4
4.2. Generator.....	5
4.3. Telescopic handle.....	6
5. Power supply	7
6. Modes.....	7
6.1. MAGNETIC FIELD DETECTOR mode.....	7
6.2. CABLE LOCATOR mode	8
7. Operating.....	12
7.1. Prepare to operating.....	12
7.2. Operating in «MAGNETIC FIELD DETECTOR» mode.....	13
7.3. Operating in «CABLE LOCATOR» mode.....	13
8. Storage.....	14
9. Transportation	14
10. Warranty.....	14

PURPOSE

The combined search device ST 600 is designed to detect electronic devices and trace cable lines.

Device can be used in combination with devices of the «ST» series:

1. Multifunctional detection device ST 500 «PIRANHA».
2. Wired communications analyzer ST 301 «SPIDER».
3. Nonlinear junction detectors ST 400, ST 401 «CAYMAN».

SPECIFICATIONS

MAIN UNIT	
magnetic field detector	
detector type	differential
frequency range, kHz	0,04 - 30
threshold sensitivity, $A/m^2 Hz^{1/2}$	10^{-7}
the detector of the electric field (cable locator receiver)	
detector type	differential
frequency, kHz	455
bandwidth, kHz	30
threshold adjustment range, dB	30
threshold sensitivity, $V/m^2 Hz^{1/2}$	10^{-7}
power supply, V	3,7
GENERATOR	
signal frequency, kHz	455
signal amplitude, V	0,1 - 3
signal modulation type	PAM (pulse-amplitude modulation)
power supply, V	3,7
MASS AND DIMENSIONS:	
main unit weight, kg	0,34
dimensions of the main unit, mm	212 x 64 x 60
generator weight, kg	0,2
generator dimensions, mm	110 x 64 x 60
kit weight in packaging, kg	2,7
kit dimensions per pack, mm	500 x 160 x 220

DELIVERY KIT

#	Item	Quantity
1.	Main unit	1
2.	Generator	1
3.	Headphones	1
4.	Battery charger	1
5.	Removable telescopic handle	1
6.	Cable for connecting to computer sockets RJ45	1
7.	Cable for connecting to computer sockets RJ12, RJ11, RJ25	1
8.	Generator ground cable	1
9.	Probe with crocodile clam	1
10.	Case (not shown in figure)	1
11.	Operating manual (not shown in figure)	1

The number of the element in the table corresponds to the number in fig.1



fig.1

4. DESIGN

4.1. MAIN UNIT

In the main unit are located:

1. The magnetic field detector (frequency range 0.3 - 10 kHz) is designed to detect low-frequency radiation. Signals are received by a magnetic antenna.
2. Cable locator receiver (operating at 455 kHz) Signals are received by a differential electric antenna.

Both antennas are located in the main unit. Power is supplied from the battery. The main unit is equipped with controls, displays and connectors for headphones and a battery charger.

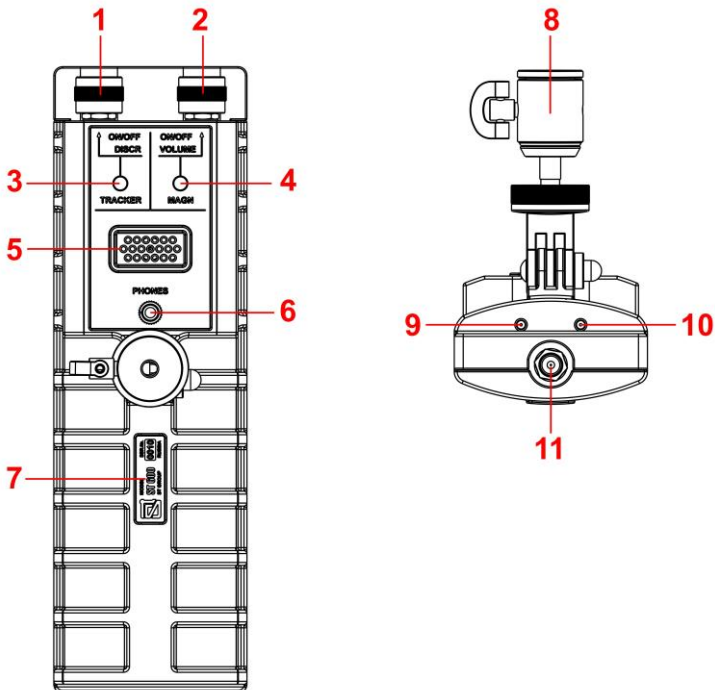

fig.2

The numbers in fig.2 denote:

- 1 - switch «CABLE LOCATOR» mode and set discrimination threshold
- 2 - switch «MAGNETIC FIELD DETECTOR» mode and adjustment the volume
- 3 - cable locator turn on indicator («TRACKER»)
- 4 - magnetic field detector turn on indicator («MAGN»)
- 5 - built-in speaker
- 6 - headphone socket
- 7 - information board
- 8 - adjustable bracket
- 9 - battery discharge indicator (red)
- 10 - battery charge indicator (green)
- 11 - charger connector

An adjustable bracket is installed on the device body (fig.2, pos.8). The bracket allows you to fix the main unit on the telescopic handle (fig.1, pos.5) and fix it in the desired position relative to the examined surface.

4.2. GENERATOR

The generator is a functionally complete self-powered device (battery). The appearance of the generator is shown in fig.3. The generator is used when cable tracing («Cable locator» mode).

The generator is designed to supply a test signal to the tested wire line.

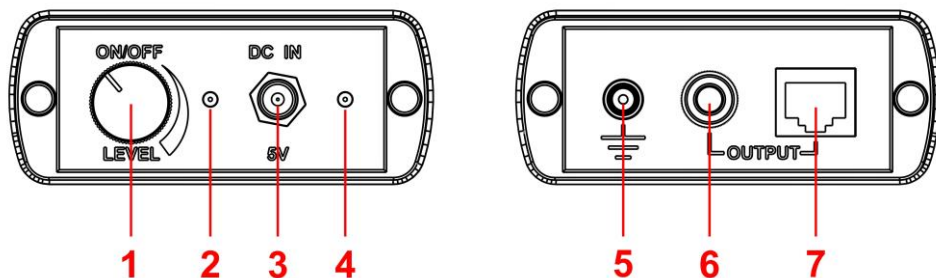

fig.3

The numbers in fig.3 denote:

- 1 - knob on/off and adjust the of the test signal level
- 2 - battery discharge indicator (red)
- 3 - charger socket
- 4 - battery charge indicator (green)
- 5 - grounding cable
- 6 - probe connection socket
- 7 - socket for cables with RJ plugs

4.3. TELESCOPIC HANDLE

Removable telescopic handle designed to hold the main unit during operation. If necessary, examine the removed surface, it is possible to increase its length.

Appearance of the telescopic handle is shown in fig.4.

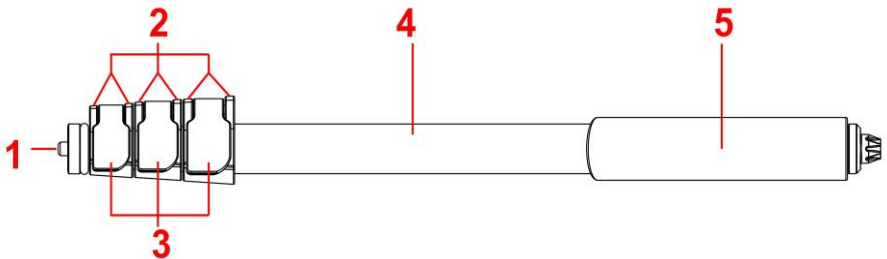

fig.4

The numbers in fig.4 denote:

- 1 - screw for mounting the main unit bracket
- 2 - eccentric retainers
- 3 - clips
- 4 - body
- 5 - handle

5. POWER SUPPLY

Power supply of the main unit and the generator is carried out from built-in batteries. Fully charged batteries ensure continuous operation of the main unit and the generator for 7 hours. The power control of the main unit is carried out using two LEDs (Fig. 2, p.9 and p.10). With a fully charged battery in operating mode, both LEDs do not glow. When the battery is discharged, a red LED lights up (Fig. 2, p. 9). The battery of the main unit is charged in the off state using the charger (Fig. 1, p. 4) while the green LED is lit (Fig. 2, P.10), which goes out when charging is complete. Full charging time of the main unit is not more than 2 hours.

The generator power supply is controlled by two LEDs (Fig. 3, p. 2 and p. 4). When the generator is turned on, the red LED lights up (Fig. 3, p. 2). When the battery is low, the red LED flashes. The generator battery is charged in the off state using a charger (Fig. 1, p. 4), while the green LED is lit (Fig. 3, p. 4), which goes out after charging. Full charge time is not more than 2 hours.

6. MODES

There are two modes of use:

1. «MAGNETIC FIELD DETECTOR» mode («DETECTOR»)
2. «CABLE LOCATOR» mode

At the same time, the device can work only in one of the modes.

6.1. «DETECTOR» MODE

Purpose - search for working listening devices. The mode is implemented by receiving, converting and indicating electromagnetic signals arising from the operation of electronic devices. For reception of signals the built-in magnetic antenna is used.

The frequency range of the antenna (0.04 - 30 kHz) allows you to detect devices in shielded enclosures.

The orientation of the main unit when operating in the “DETECTOR”

mode is shown in fig.5 (the direction to the search object is indicated by arrows). The recommended speed of movement of the main unit relative to the object being inspected is 3-5 cm/sec.

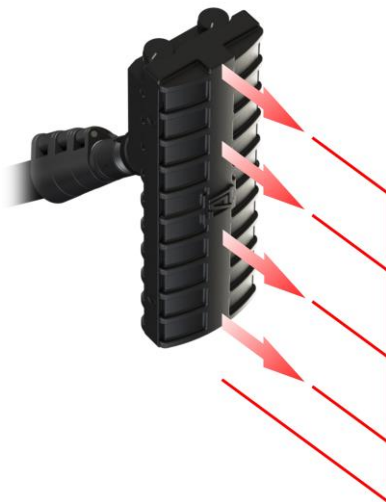

fig.5

Received signals are heard in headphones. Rhythmic or periodic signals (clicks, whistles, trills, etc.) indicate the presence of working electronic devices near the antenna. Detection range from 5 to 30 cm.

6.2. CABLE LOCATOR MODE

Purpose - tracing cables when searching for wire listening devices.

The mode is implemented by applying a test signal (455 kHz, modulated by dual tone low frequency signal) to the wired line and its reception by antennas of the main unit.

Test signal is generated and fed into the cable by the generator (fig.1, pos.2). To compensate for the attenuation of the signal, generator power adjustment is provided.

The generator is equipped with two output connectors. If the line is equipped with plugs or sockets of the RJ standard, an RJ45 socket is used (fig.3, pos.7). The test signal fed to the contact #4 of that socket.

If the cable to be tested is not equipped with connectors, use the socket (fig.3, pos.6) and the probe with a «crocodile type» clip.

For correct operation, the generator must be connected to the ground line (or to an extended metal structure in the room) using a cable (fig.1, pos.8).

The connection of the generator to various types of lines is shown in fig.6.

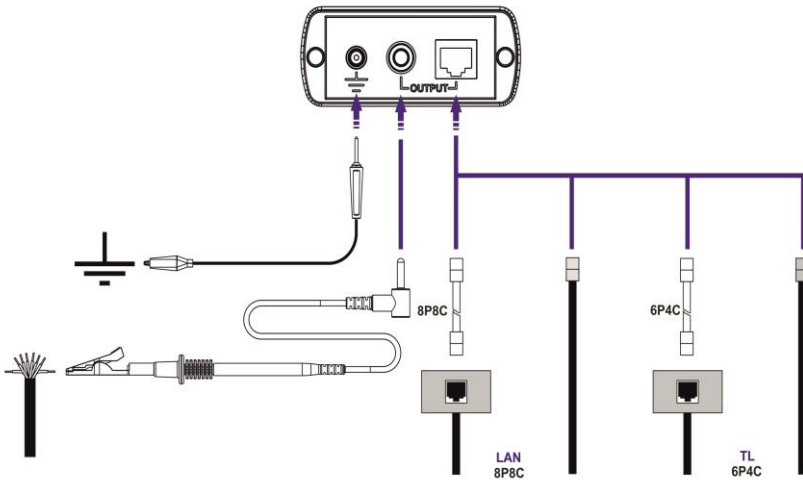

fig.6

Test signal is monitored in a contactless manner using a main unit receiver.

Operator listens to the received test signal using headphones or built-in speaker.

Receiver of the cable locator has a differential electric antenna located in the main unit.

There are **two options** for the orientation of the main unit relative to the search object:

1. Side faces of the main unit are perpendicular to the surface plane (fig.7, direction 1);
2. Front surface of the main unit is parallel to the search plane (fig.7, direction 2).

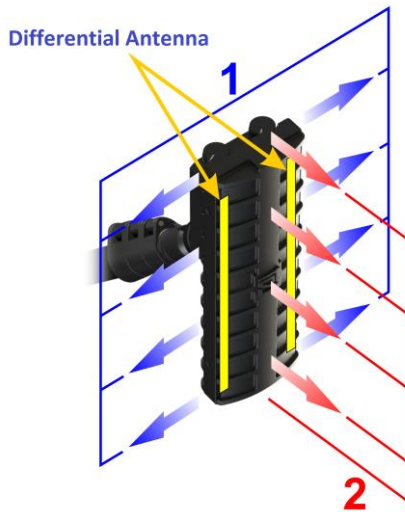

fig.7

When tracing, depending on the orientation of the main unit relative to the search plane, the level of the signal being listened to will change.

Fig. 8 shows a diagram of the change in the level of the signal being listened, when the front surface of the main unit moves parallel to the search plane (fig.7, direction 2).

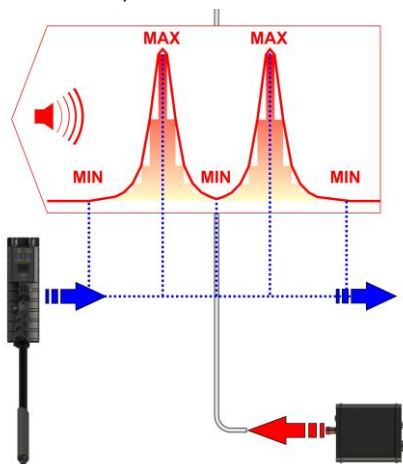

fig.8

The signal is received simultaneously on both antennas and a differential processing mode is implemented (the difference in signal levels from both antennas is determined).

When the receiver approaches the cable, the signal level received by the antenna located closer to the cable will be significantly higher than on the other antenna.

When the distance from the cable to both antennas is equal (the receiver is strictly above the cable), the signal levels will be also equal. In this case, the difference in the values of the measured levels will be close to zero.

The cable laid in the place where there is a "MIN" between the two peaks (MAX) of the received test signal (on fig.8).

Fig.9 shows a diagram of the change in the level of the signal being listened when the main unit moves with its side face to the search plane (fig.7, direction 1).

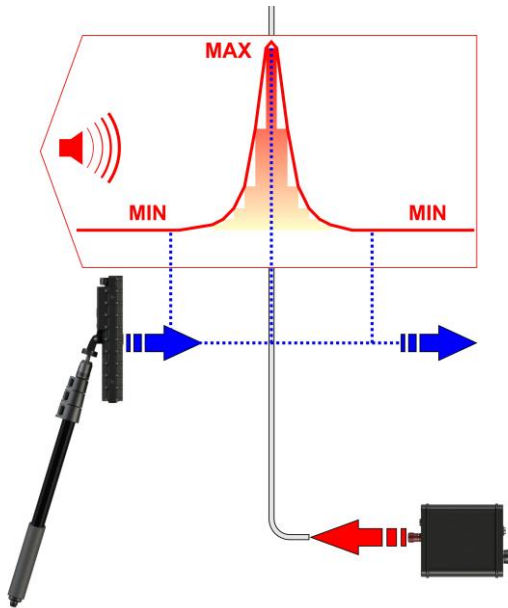

fig.9

In this case, the maximum of the received test signal will be observed above the cable location.

7. OPERATING

7.1. PREPARE TO OPERATING

1. Inspect the body of the main unit, generator and telescopic handle. Bodies must not be mechanically damaged.
2. Inspect the wires. The insulation of the wires must not be broken, the connectors must not be mechanically damaged.
3. Install the main unit on the telescopic handle. Insert the handle screw into the threaded hole of the main unit bracket. Turning the telescopic handle, tighten the screw until it stops (fig.10).

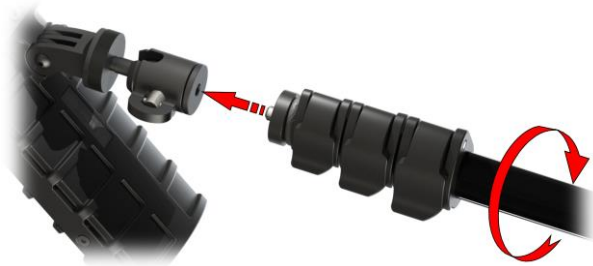

fig.10

4. Using retainers, set the desired length of the telescopic handle (fig.11).



fig.11

5. Adjust the position of the main unit relative to the handle.

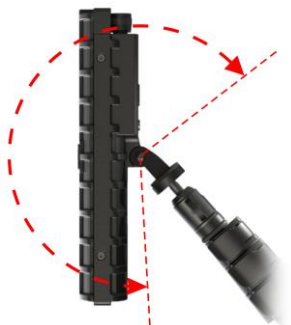

fig.12



fig.13

Fig. 12 shows how to tilt the main unit. The hinge lock allows to change the position of the main unit in any plane relative to the handle (fig.13).

7.2. OPERATING IN «MAGNETIC FIELD DETECTOR» MODE («DETECTOR»)

1. Turn on the main unit by switch (fig.2, pos.2). The device automatically switches to the “DETECTOR” mode. The «MAGN» indicator will light (fig.2, pos.4).
2. Connect headphones to the main unit (fig.2, pos.6).
3. Check battery level.
4. Adjust the headphone volume by switch (fig.2, pos.2).
5. Bring the main unit to the examination object, orienting the device as shown in fig.5.
6. Fix an acoustic signals (clicks, whistles, ticks, etc.).

7.3. OPERATING IN «CABLE LOCATOR» MODE

The procedure for operating with the generator

1. Connect the generator to the line, in accordance with fig.6.
2. Check battery level.
3. Turn on the generator by the switch (fig.3, pos.1) and set it to the middle position.

The procedure for operating with the main unit

1. Turn on the main unit (fig.2, pos.2). The «MAGN» indicator will light (fig.2, pos.4).
2. Turn on the «CABLE LOCATOR» mode (fig.2, pos.1).
3. The «TRACKER» indicator will light (fig.2, pos.3).
4. If necessary, connect headphones to the main unit.
5. Set a discrimination threshold (fig.2, pos.1). The test signal should not be heard at a distance of less than 50 cm from the generator.
6. Adjust volume level (fig.2, pos.2).
7. The search starts from the place of connection of the generator.
8. As the distance from the generator connection point increases, the test signal level may decrease due to attenuation. In this case, it is necessary to increase the level of the generator signal (fig.3, pos.1) or lower the discrimination threshold (fig.2, pos.1).

8. STORAGE

1. Ambient temperature from + 50 to - 10° C
2. Relative humidity 80% at 30° C
3. Atmospheric pressure from 630 to 820 mm Hg

9. TRANSPORTATION

Transportation must be made in a shipping container subject to protection from exposure to precipitation. Drops and sharp blows resulting in mechanical damage are not allowed.

10. WARRANTY

The manufacturer undertakes during the warranty period (12 months from the date of sale) to carry out free repair of ST 600 or its replacement on condition that the customer observes the rules of operation, transportation and storage, in the absence of mechanical damage, in the presence of a completed warranty certificate.



Russia, 192029, St. Petersburg, Obukhovskoy Oborony, 87
+7-821-412-3321, +7-812-412-4051
<http://spymarket.com/>
info@smersh.pro